

- ◆
- ◆
- ◆
- ◆
- ◆
- ◆
- ◆
- ◆
- ◆
- ◆
- ◆
- ◆
- ◆
- ◆
- ◆
- ◆
- ◆
- ◆
- ◆
- ◆
- ◆
- ◆
- ◆
- ◆

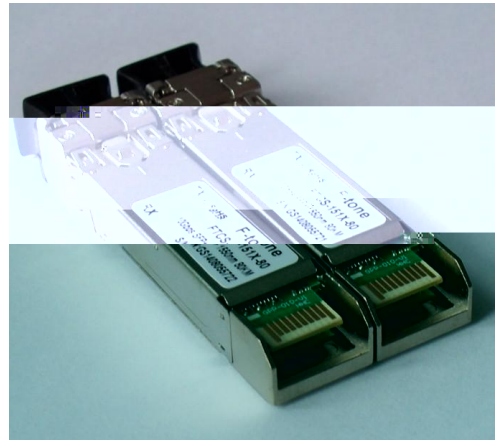

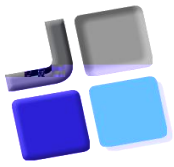

Fiber type	Minimum modal bandwidth @ 850 nm (MHz*km)	Operating range (meters)
62.5 μm MMF	160	2 to 26
	200	2 to 33
OM3 MMF	400	2 to 40
	500	2 to 52
	2000	2 to 200



				o
				o

					o

R 10¹²

Center Wavelength (nm)	RMS Spectral width (nm)								
	Up to 0.05	0.05 to 0.1	0.1 to 0.15	0.15 to 0.2	0.2 to 0.25	0.25 to 0.3	0.3 to 0.35	0.35 to 0.4	0.4 to 0.45
840 to 842	-4.2	-4.2	-4.1	-4.1	-3.9	-3.8	-3.5	-3.2	-2.8
842 to 844	-4.2	-4.2	-4.2	-4.1	-3.9	-3.8	-3.6	-3.3	-2.9
844 to 846	-4.2	-4.2	-4.2	-4.1	-4.0	-3.8	-3.6	-3.3	-2.9
846 to 848	-4.3	-4.2	-4.2	-4.1	-4.0	-3.8	-3.6	-3.3	-2.9
848 to 850	-4.3	-4.2	-4.2	-4.1	-4.0	-3.8	-3.6	-3.3	-3.0
850 to 852	-4.3	-4.2	-4.2	-4.1	-4.0	-3.8	-3.6	-3.4	-3.0
852 to 854	-4.3	-4.2	-4.2	-4.1	-4.0	-3.9	-3.7	-3.4	-3.1
854 to 856	-4.3	-4.3	-4.2	-4.1	-4.0	-3.9	-3.7	-3.4	-3.1
856 to 858	-4.3	-4.3	-4.2	-4.1	-4.0	-3.9	-3.7	-3.5	-3.1
858 to 860	-4.3	-4.3	-4.2	-4.2	-4.1	-3.9	-3.7	-3.5	-3.2

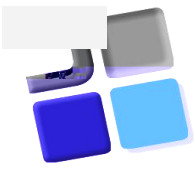

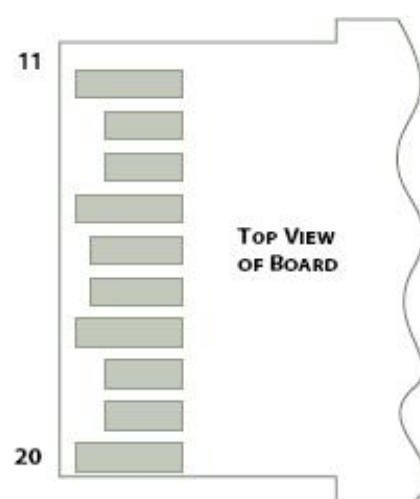
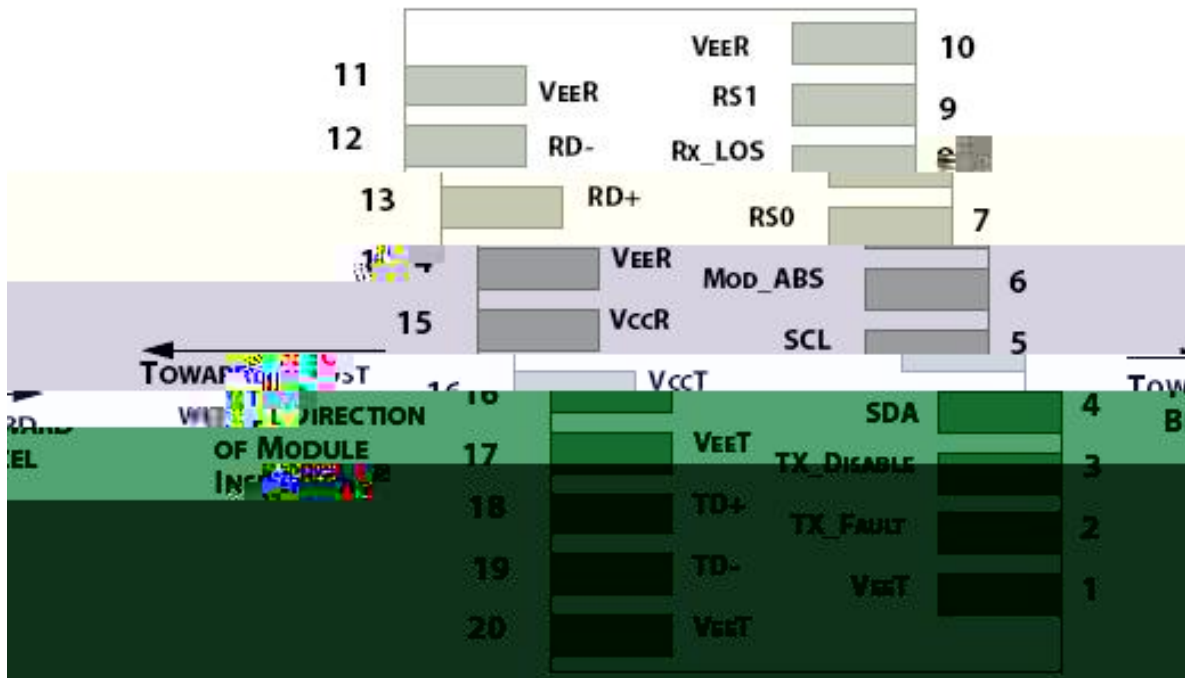

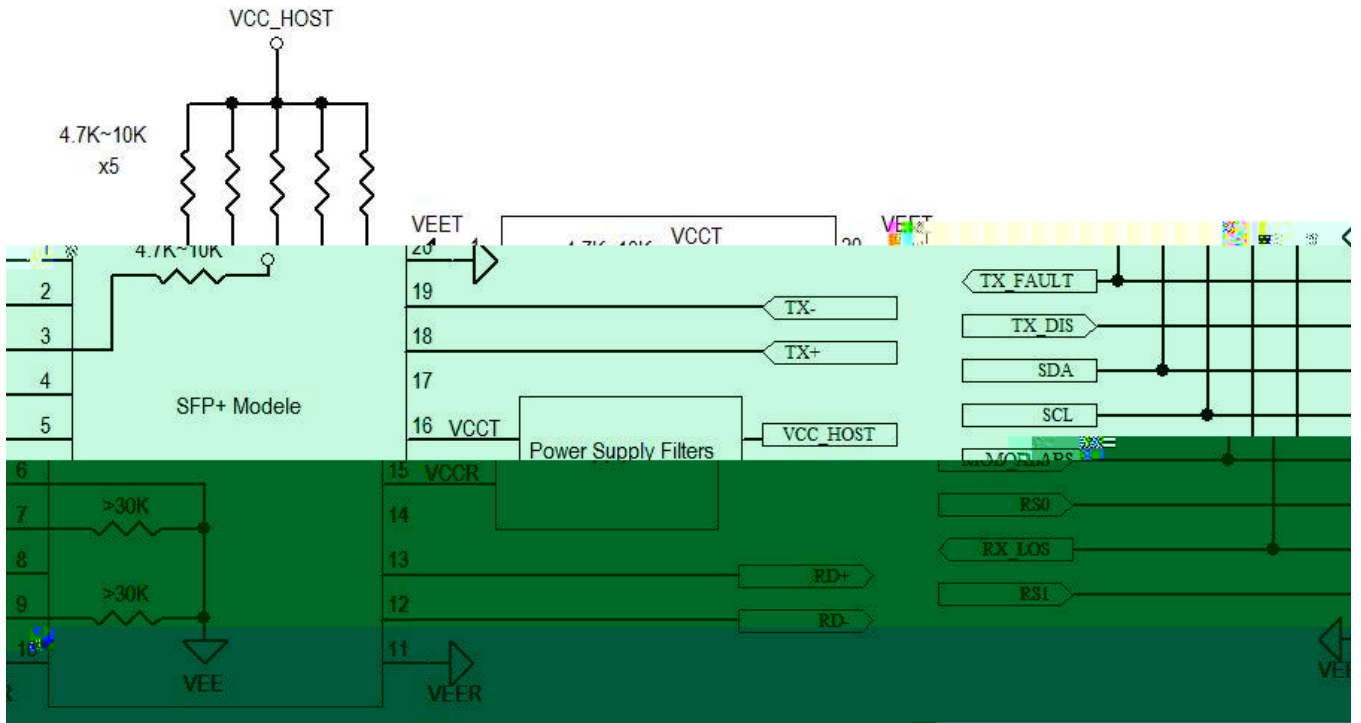
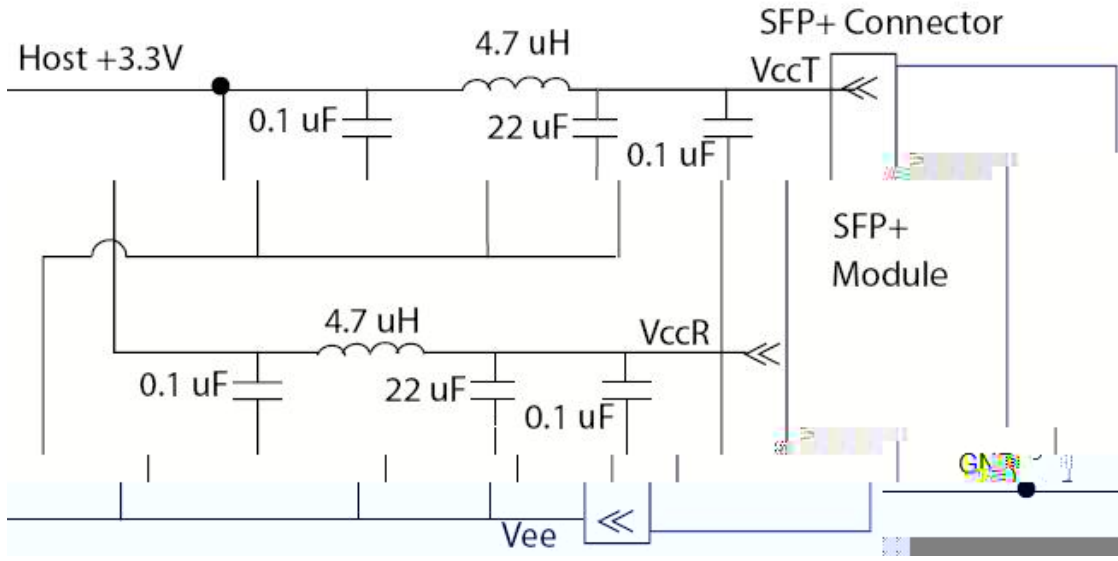

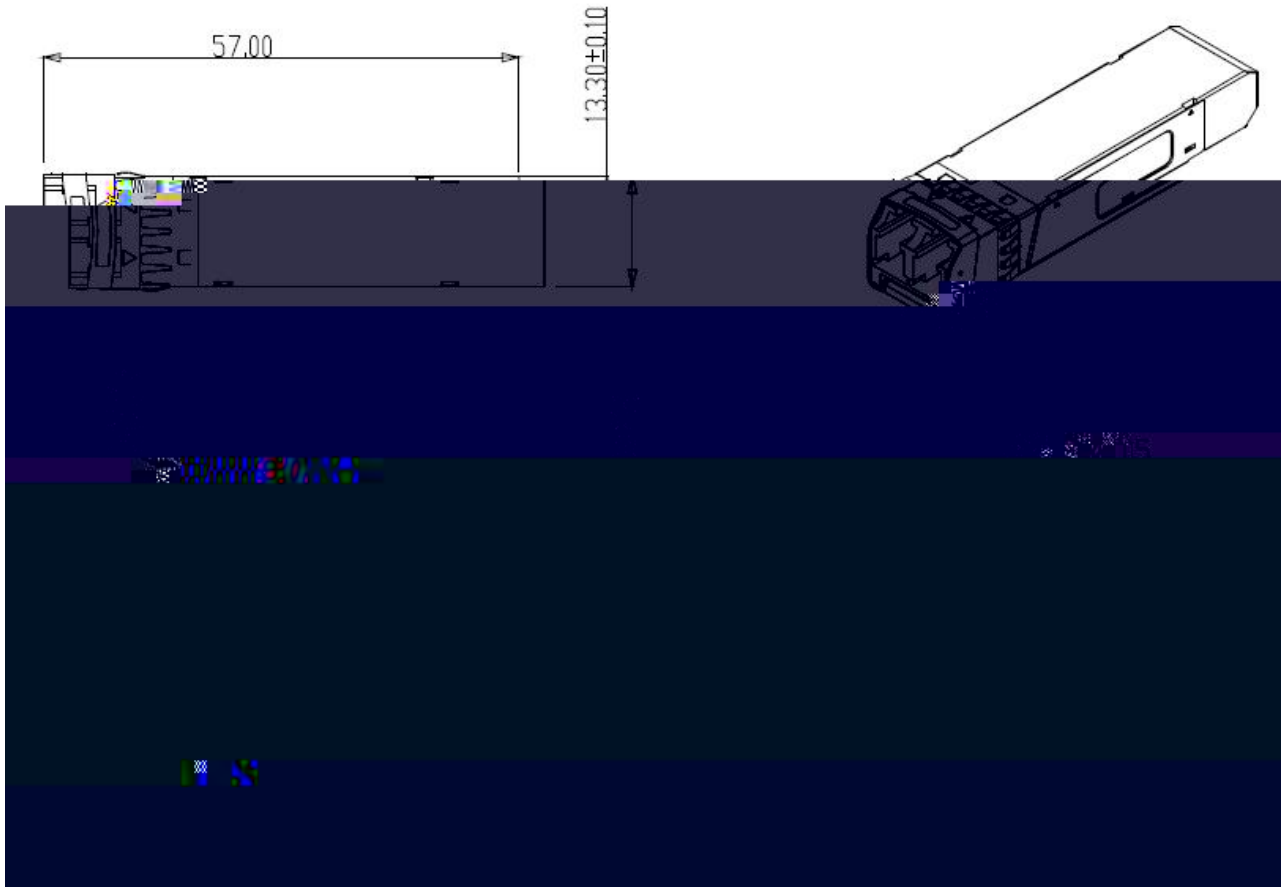



F-tone Networks

F-TONE GROUP
